

▷ Disconnecting Switch (Indoors)

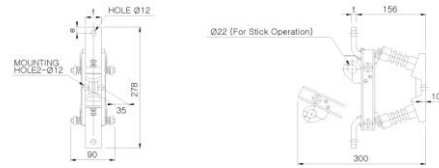

7.2kV 1P 200~630A
Insulating class : 6A(60BIL)
Rated Short-time with stand current : 25kA / 1sec
Auxiliary contacts : -
Hook

외형 치수 Dimensions, mm



TYPE	RATED VOLTAGE (kV)	RATED CURRENT (A)	a	f	t
SDV/1S/H20	7.2	200	15	30	6
SDV/1S/H40	7.2	400	15	30	10
SDV/1S/H63	7.2	630	20	35	12

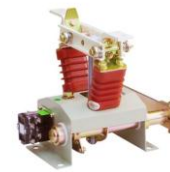

7.2kV 1P 200~600A
Insulating class : 6A(60BIL)
Rated Short-time with stand current : 25kA / 1sec
Auxiliary contacts : 2a2b~10a10b
Automatic, Manual

외형 치수 Dimensions, mm

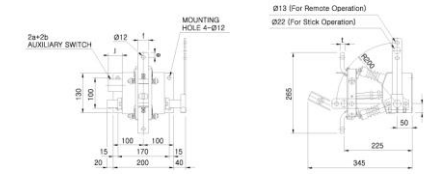

TYPE	RATED VOLTAGE (kV)	RATED CURRENT (A)	a	f	t
SDV/1SR/H20	7.2	200	15	30	6
SDV/1SR/H40	7.2	400	15	30	10
SDV/1SR/H60	7.2	600	20	35	12



7.2kV 3P 200~630A
Insulating class : 6A(60BIL)
Rated Short-time with stand current : 25kA / 1sec
Auxiliary contacts : 2a2b~10a10b
Automatic, Manual

외형 치수 Dimensions, mm

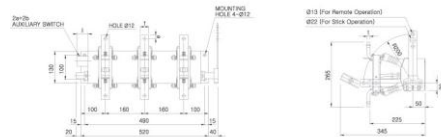

TYPE	RATED VOLTAGE (kV)	RATED CURRENT (A)	a	f	t
SDV/3S/H30	7.2	200	15	30	6
SDV/3S/H40	7.2	400	15	30	10
SDV/3S/H63	7.2	630	20	35	12



7.2kV 1P 800~1200A
Insulating class : 6A(60BIL)
Rated Short-time with stand current : 25kA / 1sec
Auxiliary contacts : -
Hook

외형 치수 Dimensions, mm

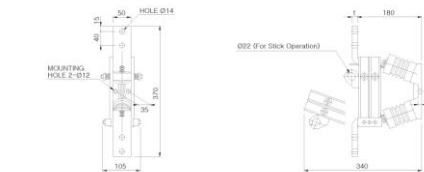

TYPE	RATED VOLTAGE (kV)	RATED CURRENT (A)	t
SDV/1SH80	7.2	800	10
SDV/1SH100	7.2	1000	12
SDV/1SH120	7.2	1200	15



7.2kV 3P 800~1200A
Insulating class : 6A(60BIL)
Rated Short-time with stand current : 31.5kA / 2sec
Auxiliary contacts : 2a2b~10a10b
Automatic, Manual

외형 치수 Dimensions, mm

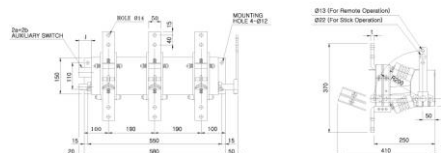

TYPE	RATED VOLTAGE (kV)	RATED CURRENT (A)	t
SDV/3S/H80	7.2	800	10
SDV/3S/H100	7.2	1000	12
SDV/3S/H120	7.2	1200	15

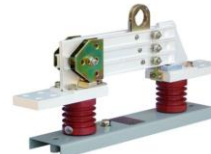

7.2kV 1P 1600~2000A
Insulating class : 6A(60BIL)
Rated Short-time with stand current : 25kA / 1sec
Auxiliary contacts : -
Hook

외형 치수 Dimensions, mm

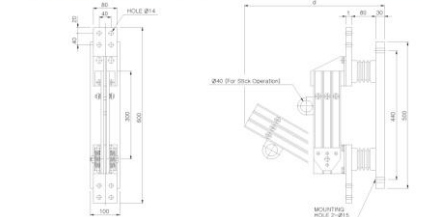

TYPE	RATED VOLTAGE (kV)	RATED CURRENT (A)	a	t
SDH/1S/H160	7.2	1600	485	15
SDH/1S/H200	7.2	2000	490	20



7.2kV 3P 1600-2000A
 Insulating class : 6A(60BIL)
 Rated Short-time with stand current : 31.5kA / 2sec
 Auxiliary contacts : 2a2b-10a10b
 Automatic, Manual

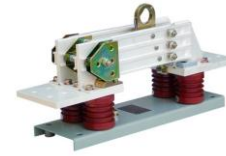
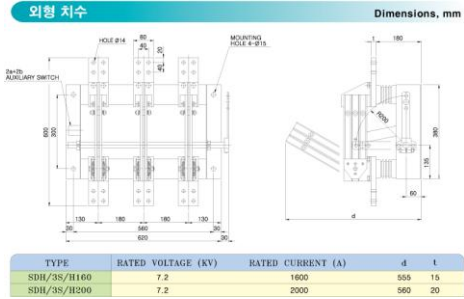

7.2kV 1P 3000-4000A
 Insulating class : 6A(60BIL)
 Rated Short-time with stand current : 40kA / 1sec
 Auxiliary contacts : -
 Hook

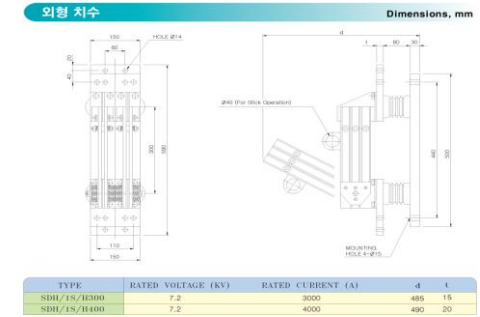

7.2kV 3P 3000-4000A
 Insulating class : 6A(60BIL)
 Rated Short-time with stand current : 40kA / 1sec
 Auxiliary contacts : 2a2b-10a10b
 Automatic, Manual

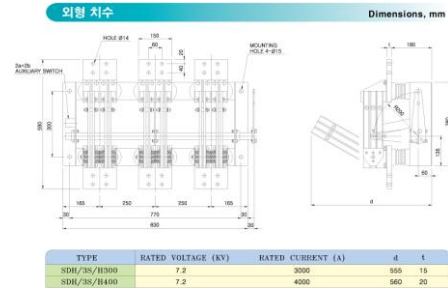

25.8kV 1P 200-600A
 Insulating class : 20A(125BIL)
 Rated Short-time with stand current : 25kA / 1sec
 Auxiliary contacts : -
 Hook

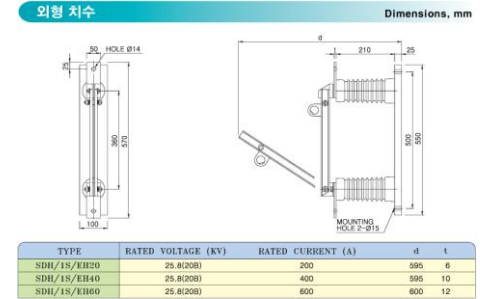

25.8kV 1P 200-600A
 Insulating class : 20A(125BIL)
 Rated Short-time with stand current : 25kA / 1sec
 Auxiliary contacts : 2a2b-10a10b
 Automatic, Manual

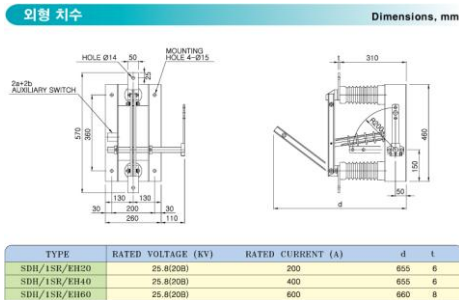

25.8kV 3P 200-600A
 Insulating class : 20B(125BIL)
 Rated Short-time with stand current : 25kA / 1sec
 Auxiliary contacts : 2a2b-10a10b
 Automatic, Manual

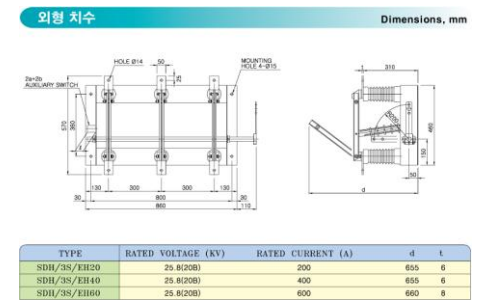



25.8kV 1P 800~1200A
 Insulating class : 20B(125BIL)
 Rated Short-time with stand current : 25kA / 1sec
 Auxiliary contacts : -
 Automatic, Manual

외형 치수 Dimensions, mm

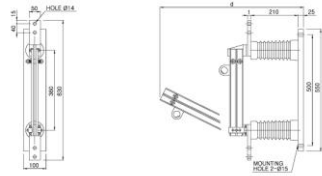

TYPE	RATED VOLTAGE (kV)	RATED CURRENT (A)	d	t
SDH/1S/EH90	25.8(20B)	800	650	10
SDH/1S/EH100	25.8(20B)	1000	650	10
SDH/1S/EH120	25.8(20B)	1200	655	12



25.8kV 3P 800~1200A
 Insulating class : 20B(125BIL)
 Rated Short-time with stand current : 40kA / 1sec
 Auxiliary contacts : 2a2b~10a10b
 Automatic, Manual

외형 치수 Dimensions, mm

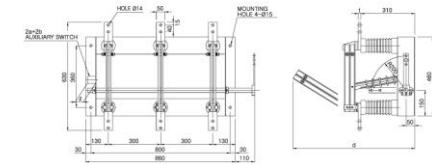

TYPE	RATED VOLTAGE (kV)	RATED CURRENT (A)	d	t
SDH/3S/EH90	25.8(20B)	800	715	10
SDH/3S/EH100	25.8(20B)	1000	715	12
SDH/3S/EH120	25.8(20B)	1200	720	15



25.8kV 1P 1600~2000A
 Insulating class : 20B(125BIL)
 Rated Short-time with stand current : 40kA / 1sec
 Auxiliary contacts : -
 Hook

외형 치수 Dimensions, mm

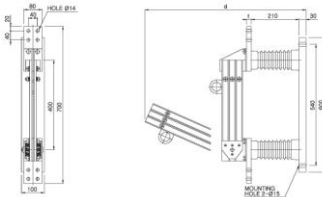

TYPE	RATED VOLTAGE (kV)	RATED CURRENT (A)	d	t
SDH/1S/EH160	25.8(20B)	1600	720	15
SDH/1S/EH200	25.8(20B)	2000	725	20



25.8kV 3P 1600~2000A
 Insulating class : 20B(125BIL)
 Rated Short-time with stand current : 40kA / 1sec
 Auxiliary contacts : 2a2b~10a10b
 Automatic, Manual

외형 치수 Dimensions, mm

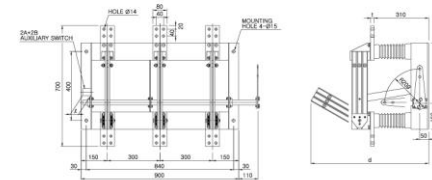

TYPE	RATED VOLTAGE (kV)	RATED CURRENT (A)	d	t
SDH/3S/EH160	25.8(20B)	1600	830	15
SDH/3S/EH200	25.8(20B)	2000	835	20



25.8kV 1P 2500A
 Insulating class : 20B(125BIL)
 Rated Short-time with stand current : 40kA / 1sec
 Auxiliary contacts : 2a2b~10a10b
 Automatic, Manual

No data available



25.8kV 4P 1600A
 Insulating class : 20A(150BIL)
 Rated Short-time with stand current : 25kA / 1sec
 Auxiliary contacts : 2a2b~10a10b
 Automatic, Manual

No data available

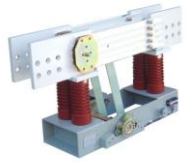

25.8kV 1P 8000A
Insulating class : 20B(125BIL)
Rated Short-time with stand current : 80kA / 1sec
Auxiliary contacts : -
Automatic, Manual

No data available